



# HEL

## Air heaters

### General information & application

HEL-1 and HEL-2 air heaters are suitable for external doors, wind cabinets, shopping malls, cafes, exhibition halls, small-scale industries, warehouses and any other location that requires effective local heating.

### Fan motors

Fans  $\varnothing$  250 mm. Stepless adjustable axial fan motors fitted with self-lubricating bearings and protected against overload. Heating capacity, air flow and at the same time noise level can be controlled by adjusting the fan speed. The fan speed controller, which includes the 0-position, is placed either on the wall or on the device itself.

### Construction

Heating coil manufactured of copper tubes and aluminum fins. Casing material plastic coated, galvanized steel sheet. Standard colour is white.

### Mounting

The device can be positioned above a suspended ceiling, flush with the underside of the roof. The outside dimensions of HEL match those of standard roofing tiles. Mounting can be done directly to the roof without air gap. Installation and maintenance is easy. The fan plate can be removed by loosening just a few screws, so all actions required for installation and maintenance can be easily performed.



HEL

Heating power, water flow and pressure drop at maximum fan speed	HEL-1			HEL-2		
	kW	l/s	kPa	kW	l/s	kPa
<b>Air temperature +20 °C</b>						
Water 90/70 °C	9.2	0.11	8.7	21.2	0.26	9.9
Water 80/60 °C	7.6	0.09	6.2	17.4	0.21	7.1
Water 80/40 °C	5.0	0.03	0.8	11.4	0.07	1.0
Water 70/40 °C	4.6	0.04	1.2	10.5	0.09	1.4
Water 60/40 °C	4.2	0.05	2.3	9.5	0.12	2.5
<b>Fans (16/70W, 1/230V/50Hz, 0.42A, 1300 rpm)</b>						
No. of fans	1			2		
Airflow	0.22 m <sup>3</sup> /s			0.47 m <sup>3</sup> /s		
Air velocity	4 m/s			4 m/s		
at 2 m distance	2 m/s			2 m/s		
Sound pressure level at a distance of 1 m	60 dB(A)			60 dB(A)		
Internal water volume	about 1 l			about 2 l		
Weight (empty)	about 15 kg			about 30 kg		

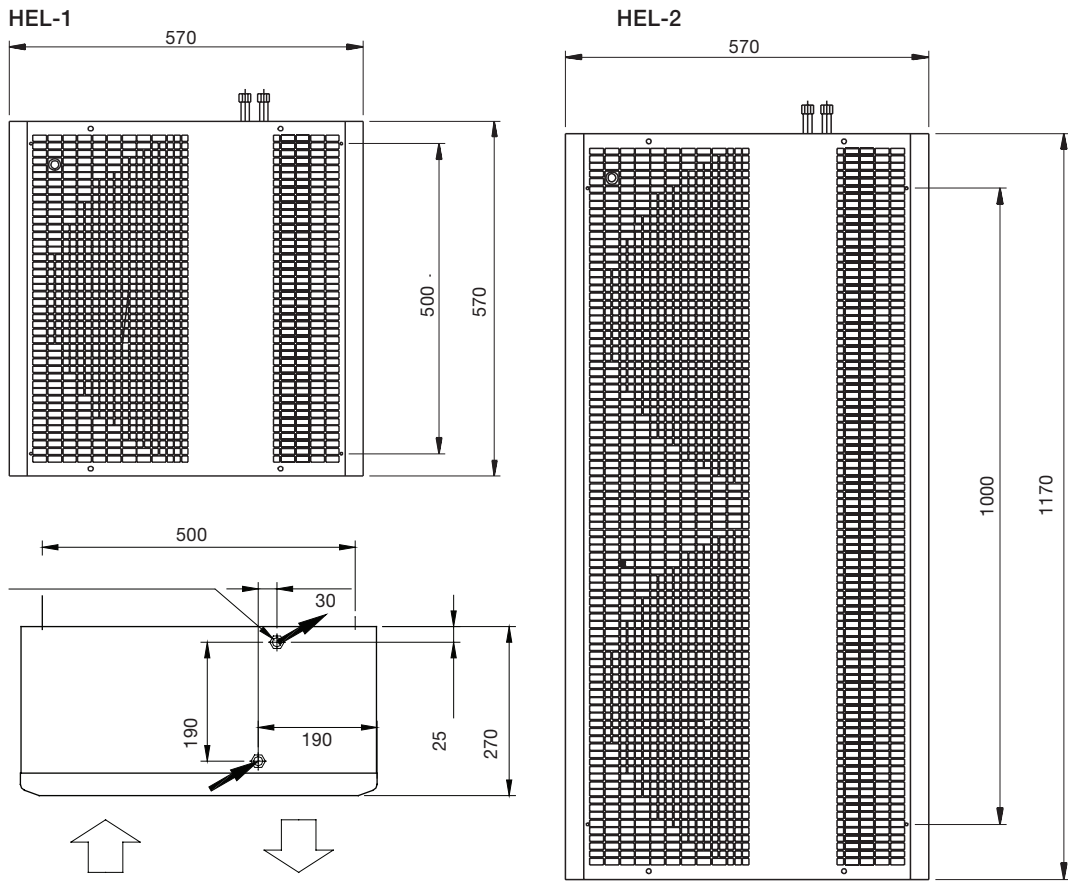

**Ceiling installation**

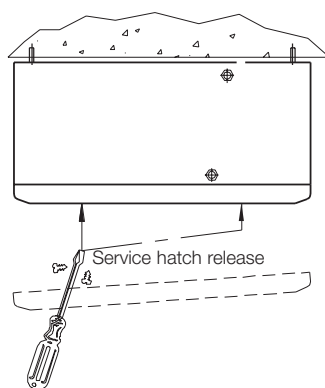
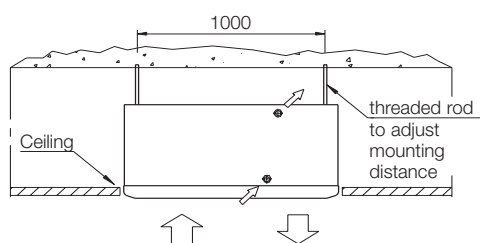

HEL can also be installed directly against the ceiling

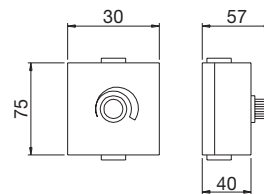
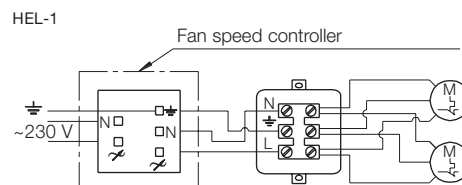
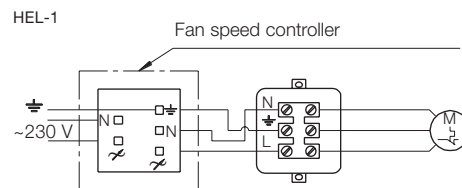

**Code description**

**HEL - 1 - PS**

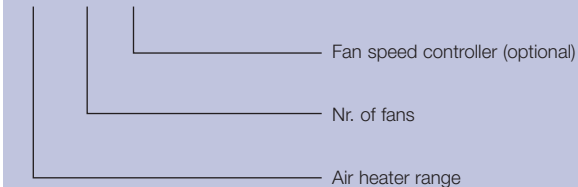

**How to contact Alfa Laval**

Up-to-date Alfa Laval contact details for all countries are always available on our website at [www.alfalaval.com](http://www.alfalaval.com)

